

---

# Operating instructions



## TARAsens sensors

### AS2, AS3

---

## Table of contents

<b>1</b>	<b>Information about these operating instructions .....</b>	<b>4</b>
1.1	Symbols and displays.....	4
1.2	Associated documents .....	5
<b>2</b>	<b>Information on this product.....</b>	<b>6</b>
2.1	Product description.....	6
2.2	Scope of supply .....	8
2.3	Accessories .....	9
2.4	Product overview .....	10
2.5	Name plate .....	11
<b>3</b>	<b>Safety .....</b>	<b>12</b>
3.1	Use for the intended purpose.....	12
3.2	Use other than for the intended purpose.....	12
3.3	Personal qualifications .....	13
3.4	Rebuilding and modifications .....	13
3.5	Residual risks .....	13
<b>4</b>	<b>Commissioning.....</b>	<b>17</b>
4.1	Installation requirements .....	17
4.2	Preparation of the sensors .....	17
4.3	Fitting the RV1 to the sensor.....	18
4.4	Inserting the sensor into the flow chamber .....	20
4.5	Electrical connection .....	21
4.6	Initial calibration.....	23
<b>5</b>	<b>Calibration .....</b>	<b>24</b>
<b>6</b>	<b>Removal.....</b>	<b>25</b>

---



<b>7</b>	<b>Maintenance .....</b>	<b>26</b>
7.1	Maintenance overview.....	26
7.2	Cleaning the electrodes .....	27
7.3	Changing the electrolyte .....	28
7.4	Maintenance of the RV1.....	29
<b>8</b>	<b>Troubleshooting .....</b>	<b>30</b>
8.1	Fault overview .....	31
8.2	Special checks .....	38
<b>9</b>	<b>Technical data.....</b>	<b>41</b>
<b>10</b>	<b>Deinstallation and storage.....</b>	<b>41</b>
10.1	Wet storage .....	41
10.2	Dry storage (only for the AS2).....	41
<b>11</b>	<b>Disposal.....</b>	<b>42</b>
<b>12</b>	<b>Warranty .....</b>	<b>42</b>
<b>13</b>	<b>Liability disclaimer .....</b>	<b>42</b>

# 1 Information about these operating instructions

## 1.1 Symbols and displays







### 1.1.1 Safety and warning instructions

The hazard symbols and signal words listed below are used in these operating instructions. They help you use the product safely, protect the operating personnel against injuries and protect the operating company against damage to property and additional costs.

	<b>Signal word</b>	<b>Meaning</b>
	<b>DANGER!</b>	DANGER means a hazard with a high degree of risk which if not avoided will lead to death or serious injury.
	<b>WARNING!</b>	WARNING means a hazard with a medium degree of risk which if not avoided may lead to death or serious injury.
	<b>CAUTION!</b>	CAUTION means a hazard with a low degree of risk which if not avoided may lead to minor or moderate injury.
	<b>NOTE</b>	NOTE warns against damage to property.

Tab. 1: *Signal words*

## 1.1.2 Displays in the text

Symbol	Meaning
	This symbol is the general warning symbol and warns you about risks of injury. Take all the actions that are indicated by this warning symbol.
	This symbol indicates tips and helpful information for optimum and economic use of the product.
	This symbol indicates actions to be performed by the personnel.
	This symbol indicates the result of an action.
	This symbol indicates individual bullet points.
	This symbol indicates a precondition before performing an action.

Tab. 2: Symbols in the text

## 1.2 Associated documents

Data sheets on the individual types of sensors can be found at the following Internet address:

<https://reiss-gmbh.com/data-sheets/?lang=en>

## 2 Information on this product

### 2.1 Product description

The sensors in the TARAsens product range are 3-electrode systems without covering membranes for measurement of the disinfectants chlorine<sup>1</sup> or chlorine dioxide dissolved in water. These sensors are characterised by the ability to operate at high pressures. In addition, TARAsens AS3 sensors can be used when the water being measured is at high temperatures.

The area of application of these sensors comprises water with qualities similar to those of drinking water, especially at high pressures and/or high temperatures. The sensors are fitted as standard with a retaining ring.

The sensors are not suitable for checking the absence of chlorine or chlorine dioxide.

A complete measuring and/or control system normally consists of the following components:

- Sensor
- Electrical leads and connectors
- Flow chambers and connections
- Measuring and control device
- Dosing equipment
- Analytical equipment



These operating instructions relate exclusively to the sensor.

- ▷ Comply with the operating instructions for the peripheral devices.

---

<sup>1</sup> Free chlorine (dependent on the pH value)

---

### **2.1.1 Chlorine**

The sensor measures the concentration of free chlorine in the water being measured, resulting from the application of inorganic chlorine products (such as chlorine gas, sodium hypochlorite solution, calcium hypochlorite solution).

The sensor can be used in the pH range from pH 5.0 to pH 9.0. It is essential to keep the pH value at a constant level, since the sensor signal is pH-dependent. The sensor shows different chlorine values different values depending on the pH value although no change in the chlorine concentration can be recognised in the DPD-1 measuring values.

### **2.1.2 Chlorine dioxide**

The sensor measures the concentration of chlorine dioxide in the water being measured, resulting from the application of chlorine dioxide (created for example by the acid/chlorite process, chlorine/chlorite process). The chlorine dioxide sensor is virtually insensitive to chlorine.

### **2.1.3 RV1 cleaning device**

The RV1 cleaning device ensures continuous automatic mechanical cleaning of the surfaces of the electrodes. This extends the maintenance intervals, because the signals from the sensors remain stable over a longer period.



The use of the RV1 reduces the nominal measuring range.

## 2.2 Scope of supply

- ▶ Keep the all the packaging for the sensor.
- ▶ In the event of repair or warranty please return the sensor in its original packaging.
- ▶ Check that the delivery is complete and undamaged.

If it is damaged:

- ▶ Please contact your supplier.

Component	Quantity	Sensor with voltage output signal  (0...+/-2000 mV)	Sensor with 4-20 mA current loop output signal		Sensor with Modbus signal transmission
			(2-pole screw terminal connection)	(5-pole M12 connection)	
Sensor (depending on the type)	1	✓	✓	✓	✓
Electrolyte (depending on the type)	1 bottle	✓	✓	✓	✓
mA hood with O-ring 20 x 1.5	1	–	✓	–	–
Retaining ring	1	✓	✓	✓	✓
Slide ring	1	✓	✓	✓	✓
O-ring 25 x 2.5	1	✓	✓	✓	✓
Special emery paper (depending on the type)	1	✓	✓	✓	✓
Operating instructions	1	✓	✓	✓	✓

Tab. 3: Scope of supply



---

## 2.3 Accessories

Designation	Article number
RV1-M <ul style="list-style-type: none"><li>• RV1 with O-ring 20 x 1.5 and 25 x 2.5</li><li>• 2 bags each with 3 cleaning balls</li><li>• Special emery paper S3</li></ul>	12112

*Tab. 4: Accessories*

## 2.4 Product overview

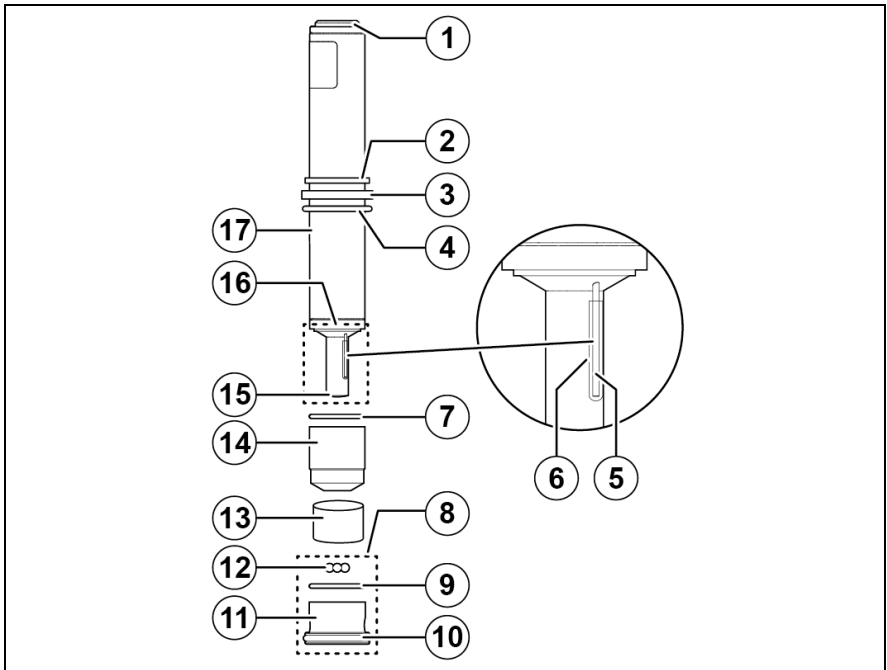

Fig. 1: Product overview

- |   |                                  |    |  |
|---|----------------------------------|----|--|
| 1 | Electrical connection            | 10 | O-ring 25 x 2.5  |
| 2 | Retaining ring                   | 11 | RV1 housing  |
| 3 | Slide ring                       | 12 | Cleaning balls   |
| 4 | O-ring 25 x 2.5                  | 13 | Protective cap   |
| 5 | Reference electrode              | 14 | Sleeve   |
| 6 | Reference cartridge <sup>2</sup> | 15 | Electrodes<br>(Working electrode/counter<br>electrode) |
| 7 | O-ring 20 x 1.5                  | 16 | Electrode finger                                       |
| 8 | RV1                              | 17 | Sensor body  |
| 9 | O-ring 20 x 1.5                  |    |  |

<sup>2</sup> Only for TARAsens AS3

## 2.5 Name plate

A name plate is glued to each sensor, this shows the following information:

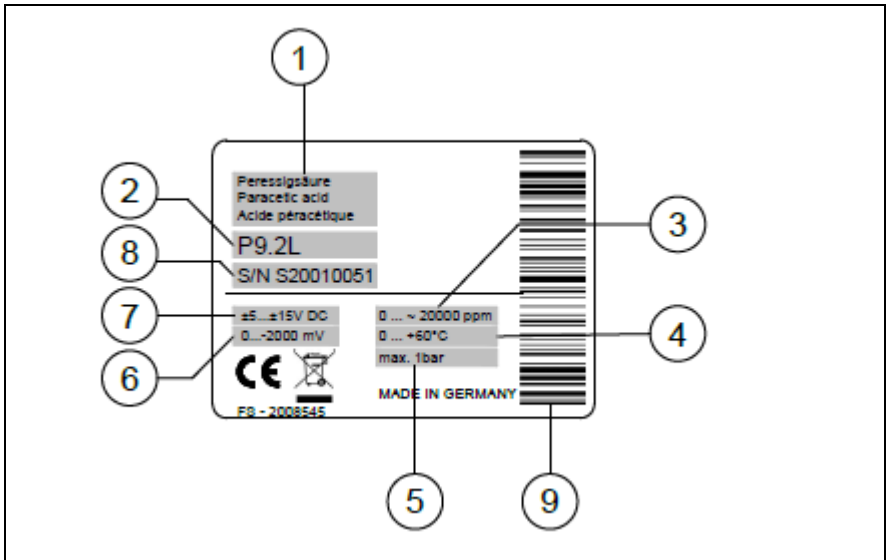

Fig. 2: Example of a name plate

- 1 Measured variables
- 2 Sensor designation, sensor name
- 3 Nominal measuring range of the sensor<sup>3</sup>
- 4 Permissible temperature range of the measuring water
- 5 Maximum permissible pressure of the water being measured
- 6 Signal transmission
- 7 Power supply
- 8 Serial number
- 9 Serial number as barcode

<sup>3</sup> Without RV1

## 3 Safety

The sensor is manufactured using the latest technology.

Nevertheless, improper use can give rise to the following risks:

- Effects on health
- Falsification of measuring values, which can lead to dangerous dosing of incorrect quantities of the disinfectant.
- ▶ Comply with the safety instructions in these operating instructions.

### 3.1 Use for the intended purpose

The sensor is intended to be used for measuring the concentration of a specific disinfectant in water.

The sensor may be used only under the following conditions:

- For the disinfectant specified in the respective data sheet.
- Under the conditions of use specified on the respective data sheet.
- Upright installation in a suitable flow chamber (electrical connection top).
- Restricted to the activities described in these operating instructions.
- Use only when in fault-free condition
- Use of original accessories and spare parts (see <https://reiss-gmbh.com/data-sheets/?lang=en>)

### 3.2 Use other than for the intended purpose

The sensor may not be used for measurements to demonstrate the absence of the disinfectant.

The sensor must not be used for applications beyond the intended purpose (see section 3.1, p. 12).

---

### 3.3 Personal qualifications

The user must hold the following personal qualifications:

- He must have read and understood the operating instructions.
- He must have received training in the handling of the sensor.

### 3.4 Rebuilding and modifications

Opening the sensor and making modifications to it which can affect the safety and functionality of the sensor may be performed only by the manufacturer.

### 3.5 Residual risks

#### 3.5.1 Slippage of the sensor

If the sensor is inadequately secured, it may become loose due to the pressure of the water or due to vibration. This results in the following risks:

- Due to the pressure of the water the sensor may slip out of the flow chamber.
- Due to its own weight the sensor may slip down into the flow chamber.
  - ▶ Make sure that the fixation of the sensor in the flow chamber cannot be loosened during operation.
  - ▶ Check the sensor regularly for secure attachment.

#### 3.5.2 High water pressure

The sensor may be damaged if the water pressure exceeds the maximum permissible value.

- ▶ Comply with the permissible pressure stated on the data sheet (see section 1.2, p. 5).

### 3.5.3 Impacts, shocks and improper touching

Impacts or shaking of the sensor, such as by dropping it, can damage it.

- ▶ Avoid impacts and shocks.
- ▶ Do not allow the sensor to be dropped.



Do not touch the sensor electrodes at any time.

Touching the reference electrode, or using emery paper on it, can damage it.

- ▶ Do not touch the reference electrode.



For the TARAsens AS3:

- ▶ Do not remove the reference cartridge.
- ▶ During maintenance work, use emery paper only on the working electrode/counter electrode as necessary, **not** on the reference electrode.

### 3.5.4 Electrical interference

A lack of galvanic isolation can falsify the measuring value and even damage the sensor beyond repair.

- ▶ Ensure the electrical connection has galvanic isolation.

Electrical interference on the signal lead can damage the electronics.

- ▶ Ensure the connection is made correctly (see section 4.5, p. 21).

### 3.5.5 Lack of disinfectant

If for a prolonged period there has been no disinfectant in the water, a film of biological matter may accumulate on the electrodes. This falsifies the measured value, and means maintenance must be performed on the sensor (see section 7.2, p. 27).

- ▶ Make sure that the period during which there is no disinfectant present is not longer than specified on the data sheet (see section 1.2, p. 5).

---

### **3.5.6 Loss of measuring values when the sensor is removed**

After the sensor has been removed there is no longer a measuring value, which can lead to incorrect dosing of the disinfectant.

- ▶ Switch off the measurement and control system or switch it over to manual operation.

### **3.5.7 Oxidants, reducers and corrosion inhibitors**

Oxidants, reducers and corrosion inhibitors in the water interfere with measurement and can lead to measuring errors.

- ▶ Make sure there are no oxidants, reducers or corrosion inhibitors in the water.
- ▶ Comply with the instructions on the data sheet (see section 1.2, p. 5).

### **3.5.8 pH value (only chlorine)**

If the pH value in the water changes or if the pH value lies outside the permissible range the measuring value can be falsified.

- ▶ Make sure that the pH value lies within the permissible range.
- ▶ Make sure that the pH value is kept constant.
- ▶ Comply with the instructions on the data sheet (see section 1.2, p. 5).

### **3.5.9 Temperature and fluctuations in temperature**

If the ambient temperature or the temperature of the medium lies outside the permissible range, the sensor and the electrolyte may be damaged.

- ▶ Make sure that in all the operating phases the temperatures comply with the permissible values specified on the data sheet (see section 1.2, p. 5).

The measuring value can be falsified if the temperature in the medium fluctuates abruptly.

- ▶ Make sure that the temperature in the water changes only slowly.

### **3.5.10 Impermissible installation position**

If the sensor is not installed upright the measuring value can be falsified.

- ▶ Install the sensor upright (electrical connection top).

### **3.5.11 Incorrect chemical analytical methods**

Incorrect determination of the concentration of the disinfectant will lead to incorrect calibration of the sensor.

- ▶ Employ the recommended analytical methods as specified on the data sheet (see section 1.2, p. 5).
- ▶ Perform analytical work in accordance with the specifications in the manufacturer's operating instructions for the analytical equipment.



## 4 Commissioning

The sensor is supplied ready for operation, i.e. the sleeve is already filled with electrolyte.

### 4.1 Installation requirements

The following installation requirements must be satisfied:

- Continuous power supply and presence of water being measured
- Through flow rate as specified on the data sheet
- Constant through flow rate
- There must be disinfectants present in the water being measured.
- There must be galvanic isolation at the electrical connections (if not already present in the sensor, see data sheet, section 1.2, p. 5)
- The water being measured must not be evolving gas at the measurement point.

### 4.2 Preparation of the sensors

- ▶ Grasp the sensor by the sleeve, and unscrew the protective cap.

 The protective cap is filled with electrolyte.

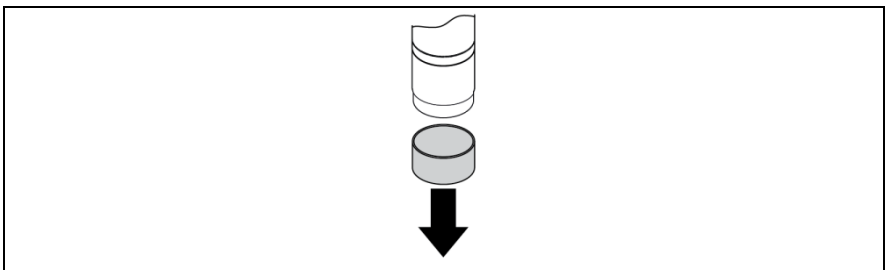

Fig. 3: *Unscrewing the protective cap*

If the sleeve was inadvertently loosened:

- ▶ Top up the electrolyte (see section 7.3, p. 28).
- ↪ The sensor is now prepared for commissioning without the RV1.

### 4.3 Fitting the RV1 to the sensor

- ✓ The sensor must have been prepared for installation (see section 4.2, p. 17).
- ▶ Check that the retaining ring, slide ring and O-ring 25 x 2.5 [1] are correctly positioned on the sensor.
- ▶ Unscrew the TARAflow FLC flow chamber.
- ▶ Take the O-ring retainer [2] off the TARAflow FLC.
- ▶ Working from the electrodes end, slide the O-ring retainer with the recess for the O-ring 25 x 2.5 on to the sensor body.

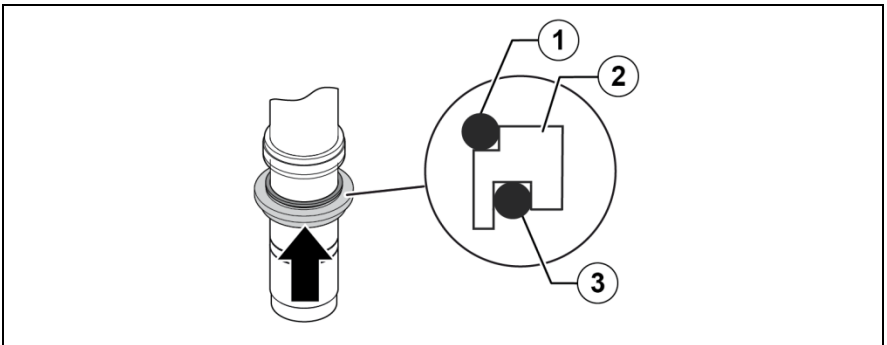

Fig. 4: Sliding the O-ring retainer on to the sensor body

- 1 O-ring 25 x 2.5
- 2 O-ring retainer
- 3 O-ring 30 x 2.6

- ▶ Take 3 cleaning balls [1] out of the bag and place them in the RV1 [2].



The additional bag contains 3 spare cleaning balls.

- ▶ Screw the RV1 on to the sleeve.

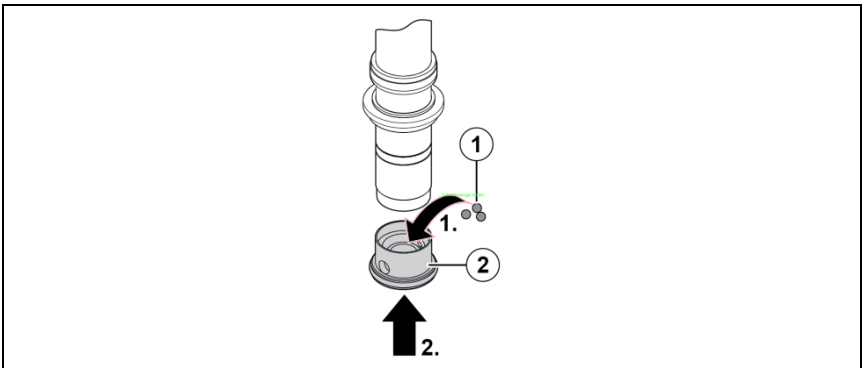

Fig. 5: Screwing the RV1 on to the sleeve

- 1 Cleaning balls
- 2 RV1

- ↪ The sensor is now prepared for commissioning with the RV1.

### 4.4 Inserting the sensor into the flow chamber

- ✓ The sensor must have been prepared for installation (see section 4.2, p. 17).

In order to insert the sensor correctly into the flow chamber:

- ▶ Comply with the instructions in the operating instructions for the “TARAflow FLC” flow chamber or the flow chamber that is used.



For correct operation of the RV1 it is essential that the TARAflow FLC flow chamber is used.



A flow rate of 45-90 l/h is necessary for correct operation of the RV1.

## 4.5 Electrical connection

- ✓ The sensor must have been inserted into the flow chamber (see section 4.4, p. 20).

The following types of electrical connections to the sensor are available:

### 4.5.1 Connection with 0...+/-2000-mV signal output

The sensor is provided with a 5-pin M12 screwed plug protected against polarity reversal. The connection pins are assigned as follows:

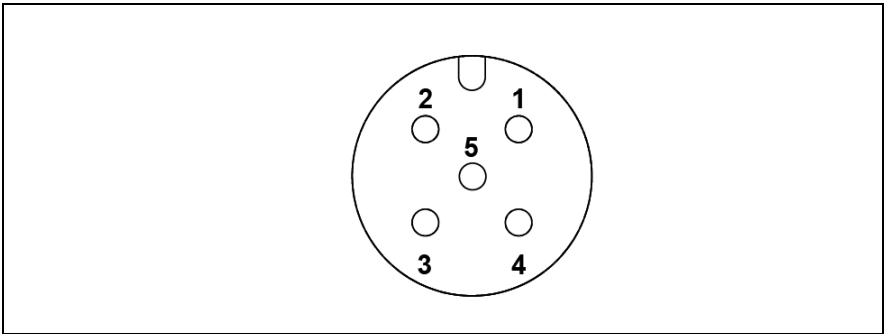

Fig. 6: Connection pin assignment (5-pin)

	Analog signal processing		Digital signal processing
	0...-2000 mV	0...+2000 mV	0...+/-2000 mV
1	Measuring signal	Measuring signal	Measuring signal
2	+U	+U	+U
3	-U	Power GND	Power GND
4	Signal GND	Signal GND	Signal GND
5	(not assigned)	(not assigned)	(not assigned)

### 4.5.2 Connection with 4...20 mA signal output

#### M12 screwed plug

The sensor is provided with a 5-pin M12 screwed plug protected against polarity reversal.

The connection pins are assigned as follows:

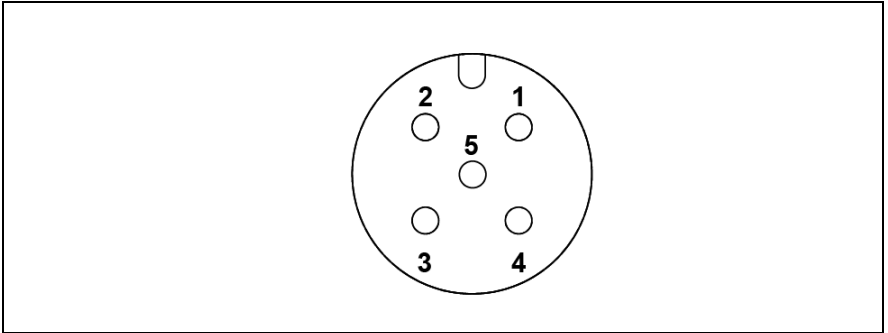

Fig. 7: Connection pin assignment (5-pin)

- 1 (not assigned)
- 2 +U
- 3 -U
- 4 (not assigned)
- 5 (not assigned)

#### Connection with a 2-pole screwed terminal block

The sensor is provided with a 2-pole screwed terminal block.

- ▶ Insert the sensor cable through the cable gland in the hood.
- ▶ Connect the cores to the terminals in the sensor electronics.
- ▶ Screw the hood finger-tight into the sensor body until the O-ring seal is made.
- ▶ Tighten the cable gland so as to secure the cable.

### 4.5.3 Connection with Modbus signal transmission

The sensor is provided with a 5-pin M12 screwed plug protected against polarity reversal. There are no termination resistors within the sensor. The connection pins are assigned as follows:

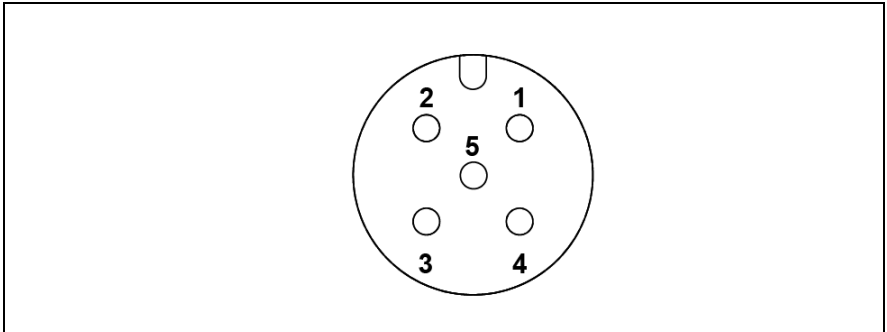

Fig. 8: Connection pin assignment (5-pin)

- 1 (reserved)
- 2 +9...+30 V
- 3 GND
- 4 RS485 B
- 5 RS485 A

### 4.6 Initial calibration

- ✓ The sensor must have been connected electrically (see section 4.5, p. 21).
- ✓ The running-in time must comply with the specification on the data sheet (see section 1.2, p. 5).
  - ▶ Perform calibration (see section 5, p. 24).
  - ▶ After one day, repeat the calibration.

## 5 Calibration

The sensor outputs a signal proportional to the concentration of the disinfectant in the water being measured. In order to assign the value of the sensor signal to the concentration of the disinfectant in the water being measured, the sensor must be calibrated.

- ✓ The flow rate must be constant.
- ✓ The temperature of the water being measured must be constant.
- ✓ Acclimatisation of the temperature of the sensor to that of the water being measured must be complete (this takes about 20 minutes after a change in temperature).
- ✓ The sensor must have completed running in.
- ✓ No other oxidant may be present in the water being measured.
- ✓ The pH value must be constant (applies only to chlorine).
- ▶ Take the analytical sample of the water being measured from near to the sensor.
- ▶ Using appropriate methods, determine the concentration of the disinfectant in the water being measured (see the manufacturer's operating instructions for the analytical equipment).
- ▶ In the calibration menu of the measuring and control device, mark up the sensor signal against the value determined by the analytical procedure (see the operating instructions for the device).
- ▶ Repeat the calibration at regular intervals (see section 7.1, p. 26).
- ▶ Comply with the applicable national regulations for calibration intervals.

Measured variables	Recommended analytical methods	
Free chlorine	DPD-1	Photometer for chlorine
Chlorine dioxide	DPD-1	Photometer for chlorine dioxide

Tab. 5: Recommended analytical methods



---

 Chlorine dioxide can also be determined using a photometer intended for chlorine. The result must be multiplied by a factor of 1.9.

At higher concentrations of disinfectant the DPD colouration may fail to appear.

## 6 Removal

 Removal of the sensor can lead to an incorrect measuring value at the input to the measuring and control device, which can cause the control circuit to apply uncontrolled dosing.

Before removing the sensor:

- ▶ Switch off the measurement and control system or switch it over to manual operation.
- ▶ Close the inlet of the water being measured.
- ▶ Close the outlet of the water being measured.
- ▶ Remove the electrical connection.

To disconnect a sensor with a 2-pole screwed terminal block:

- ▶ Undo the cable gland.
- ↪ The cable is now free to move.
- ▶ Unscrew the hood with the cable gland from the sensor.
- ▶ Release the cable cores from the terminals.
  
- ▶ Undo the screw fastening and carefully pull the sensor out.

 When removing the sensor with an RV1:

- ▶ Carefully pull the sensor out of the flow chamber, twisting it clockwise as you do so.

## 7 Maintenance

### 7.1 Maintenance overview

To ensure optimum performance of the sensor:

- ▶ Perform the following actions at regular intervals:

Maintenance task	Interval
▶ Clean the electrodes	
• Without RV1	4...12 weeks
• With RV1	6...12 months
▶ Change the electrolyte	3...6 months
▶ Change the cleaning balls	Annually
▶ Perform calibration	<ul style="list-style-type: none"> <li>• Weekly</li> <li>• After the electrolyte has been changed</li> <li>• After the cleaning balls have been changed</li> <li>• After the electrodes have been cleaned</li> </ul>

Tab. 6: *Maintenance overview*

## 7.2 Cleaning the electrodes

- ▶ Take out the sensor (see section 6, p. 25).

If an RV1 is present:

- ▶ Grip the sleeve and unscrew the RV1.
- ▶ Make sure that the cleaning balls don't escape.
- ▶ Use mains water to rinse the working electrolyte / counter electrode.
- ▶ Lay a piece of special emery paper on a paper wipe.
- ▶ Hold the sensor upright.
- ▶ Hold the special emery paper in position and move the electrodes across it at least twice. Use a fresh area of the special emery paper for each pass.



Hold the sensor in such a way that both the electrodes are drawn across the special emery paper alongside each other.

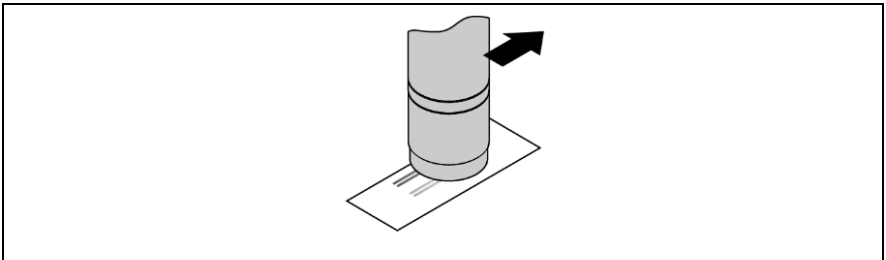

*Fig. 9: Cleaning the electrodes*

- ▶ Perform the same operations as for commissioning (see section 4, p. 17).
- ↪ Maintenance has now been completed and the sensor can be put back into use.

### 7.3 Changing the electrolyte

- ▶ Take out the sensor (see section 6, p. 25).

If an RV1 is present:

- ▶ Grip the sleeve and unscrew the RV1.
- ▶ Make sure that the cleaning balls don't escape.
- ▶ Unscrew the sleeve and use mains water to rinse it.
- ▶ Rinse the electrode finger with mains water.



Only for TARAsens AS3:

- ▶ Make sure that the reference cartridge [1] remains on the reference electrode.

If it slips down:

- ▶ Carefully push the reference cartridge back on to the reference electrode.

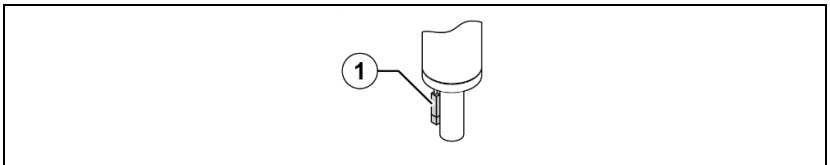

*Fig. 10: Reference cartridge on the reference electrode*

- 1 Reference cartridge

- ▶ Screw the sleeve sufficiently far down the electrode finger that the spout of the bottle of electrolyte fits into the resulting gap (approx. 5 mm).
- ▶ Fill the sleeve with electrolyte, ensuring no bubbles are present.
- ▶ Fully screw on the sleeve.

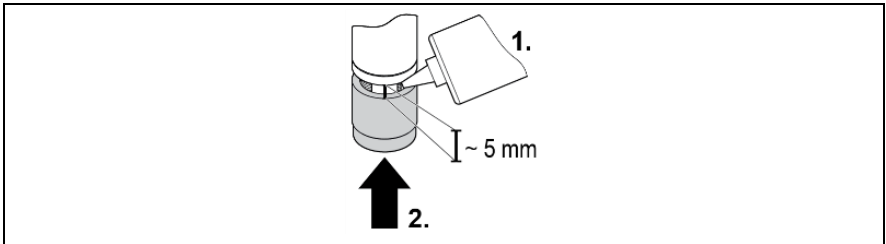

*Fig. 11: Screwing the sleeve down the electrode finger and filling it with electrolyte*

- ▶ Use mains water to rinse off any electrolyte residues adhering to the sensor.
- ▶ Perform cleaning of the electrodes as a maintenance operation (see section 7.2, p. 27).
- ▶ Perform the same operations as for commissioning (see section 4, p. 17).
- ↪ Maintenance has now been completed and the sensor can be put back into use.

## 7.4 Maintenance of the RV1

- ✓ Cleaning of the electrodes must have been performed (see section 7.2, p. 27).

Before screwing the RV1 on to the sensor:

- ▶ Insert 3 new cleaning balls into the RV1.
- ↪ Maintenance of the RV1 is now complete.
- ▶ Perform the same operations as for commissioning (see section 4.3, p. 18).

# 8 Troubleshooting

Various factors in the environment can affect the sensor. If irregularities occur, it may be useful to check these factors:

- Flow rate
- Measuring cable
- Measuring and control device
- Calibration
- Dosing equipment
- Concentration of the disinfectant in the dosing container
- Suitability of the sensor for measuring the disinfectant that is being dosed
- Concentration of the disinfectant in the water being measured (determined by analytical methods)
- pH value of the water being measured
- Temperature of the water being measured
- Pressure in the flow chamber
- Analytical methods

## 8.1 Fault overview

Fault	Cause	Corrective action
Sensor cannot be calibrated / deviation of the measuring value from DPD measurement	Run-in time too short.	<ul style="list-style-type: none"> <li>▶ Wait for run-in period (see section 4.6, p. 23).</li> <li>▶ Repeat the calibration after a few hours.</li> </ul>
	The sleeve is damaged.	<ul style="list-style-type: none"> <li>▶ Change the sleeve (see section 7.2, p. 27).</li> </ul>
	Disruptive substances in the water contents	<ul style="list-style-type: none"> <li>▶ Check the water for disruptive substances (observe data sheet)</li> <li>▶ Provide remedy.</li> <li>▶ Consult the supplier.</li> </ul>
	Short circuit / defect in the measuring lead	<ul style="list-style-type: none"> <li>▶ Locate and eliminate the short circuit / defect.</li> <li>▶ Exchange the measuring lead.</li> </ul>
	The sleeve is not fully screwed on.	<ul style="list-style-type: none"> <li>▶ Screw the sleeve on fully to the stop.</li> <li>▶ Perform maintenance on the sensor (see section 7.3, p. 28).</li> </ul>
	The DPD chemicals are past their effectiveness date.	<ul style="list-style-type: none"> <li>▶ Use new DPD chemicals.</li> <li>▶ Repeat the calibration (see section 5, p. 24).</li> </ul>

Fault	Cause	Corrective action
	Deposits on the electrodes	<ul style="list-style-type: none"> <li>▶ Clean the electrodes (see section 7.2, p. 27).</li> </ul>
	No electrolyte in the sleeve	<ul style="list-style-type: none"> <li>▶ Fill the sleeve with electrolyte.</li> <li>▶ Prepare the sensor (see section 4.2, p. 17).</li> </ul>
	The concentration of disinfectant exceeds the upper limit of the measuring range.	<ul style="list-style-type: none"> <li>▶ Check the system.</li> <li>▶ Remedy the faults.</li> <li>▶ Repeat the calibration (see section 5, p. 24).</li> </ul>
	The protective cap had not been removed before fitting the sensor.	<ul style="list-style-type: none"> <li>▶ Remove the sensor.</li> <li>▶ Remove the protective cap (see section 4.2, p. 17).</li> <li>▶ Commission the sensor (see section 4, p. 17).</li> </ul>
	Gas bubbles on the electrodes	<ul style="list-style-type: none"> <li>▶ Temporarily increase the flow rate.</li> <li>▶ Check the installation and modify it.</li> </ul>
	Analytical methods: When operating under pressure, too many gas bubbles in the in the sample of water being measured.	<ul style="list-style-type: none"> <li>▶ Repeat the analysis.</li> <li>▶ Comply with the manufacturer's operating instructions for the analytical equipment.</li> </ul>



Fault	Cause	Corrective action
	Lack of galvanic isolation	<ul style="list-style-type: none"> <li>▶ Create galvanic isolation.</li> <li>▶ Return the sensor to the supplier for checking / reconditioning.</li> </ul>
	The sensor is defective.	<ul style="list-style-type: none"> <li>▶ Return the sensor to the supplier for checking / reconditioning.</li> </ul>
Unstable measuring value	Gas bubbles on the electrodes	<ul style="list-style-type: none"> <li>▶ Temporarily increase the flow rate.</li> <li>▶ Check the installation and modify it.</li> </ul>
	Lack of galvanic isolation	<ul style="list-style-type: none"> <li>▶ Create galvanic isolation.</li> <li>▶ Return the sensor to the supplier for checking / reconditioning.</li> </ul>
	The reference electrode is exhausted and/or contaminated. <sup>4</sup>	<ul style="list-style-type: none"> <li>▶ Return the sensor to the supplier for checking / reconditioning.</li> </ul>

---

<sup>4</sup> Only for TARAsens AS2: The reference electrode has a silvery sheen or is white. The usual colour on the other hand is brown/grey.

Fault	Cause	Corrective action
Overdriving <sup>5</sup>	Excessive concentration of disinfectant in the water being measured	<ul style="list-style-type: none"> <li>▶ Check the system.</li> <li>▶ Remedy the faults.</li> <li>▶ Calibrate the sensor (see section 5, p. 24).</li> <li>▶ Perform maintenance on the sensor (see section 7, p. 26).</li> </ul>
	Run-in time too short.	<ul style="list-style-type: none"> <li>▶ Wait until the run-in time has elapsed (see section 4.6, p. 23).</li> </ul>
	Flow rate too high	<ul style="list-style-type: none"> <li>▶ Check the system.</li> <li>▶ Reduce the flow rate.</li> </ul>
	Lack of galvanic isolation	<ul style="list-style-type: none"> <li>▶ Create galvanic isolation.</li> <li>▶ Return the sensor to the supplier for checking / reconditioning.</li> </ul>
	The sensor is defective.	<ul style="list-style-type: none"> <li>▶ Return the sensor to the supplier for checking / reconditioning.</li> </ul>

---

<sup>5</sup> see Tab. 8, p. 35.

Fault	Cause	Corrective action
Underdriving <sup>6</sup>	Run-in time too short.	▶ Wait until the run-in time has elapsed (see section 4.6, p. 23).
	The working electrode is contaminated.	▶ Perform maintenance on the sensor (see section 7, p. 26).
	Lack of galvanic isolation	▶ Create galvanic isolation. ▶ Return the sensor to the supplier for checking / reconditioning.
	The sensor is defective.	▶ Return the sensor to the supplier for checking / reconditioning.
Green LED failing to flash <sup>7</sup>	Defective power supply	▶ Provide the correct power supply.
	The sensor is defective.	▶ Return the sensor to the supplier for checking / reconditioning.
No signal	The sensor is connected to the measuring and control device with the wrong polarity. <sup>8</sup>	▶ Connect the sensor correctly to the measuring and control device.
	The measuring lead is broken.	▶ Exchange the measuring lead.

<sup>6</sup> see Tab. 8, p. 35.

<sup>7</sup> Only for sensors with digital electronics

<sup>8</sup> Only for sensors with 4...20-mA signal output

## Troubleshooting

---

Fault	Cause	Corrective action
	The sensor is not receiving any power supply.	▶ Provide the correct power supply.
	The sensor is defective.	▶ Return the sensor to the supplier for checking / reconditioning.

*Tab. 7: Faults overview*

Electronics	Signal transmission	Underdriving	Overdriving
Analogue	4 ... 20 mA	<4 mA	>20 mA
	0 ... +2000 mV	<0 mV	>+2000 mV
	0 ... -2000 mV	>0 mV	<-2000 mV
Digital	Modbus RTU	<0 ppm/ % <0 mA	Measured value > Measurement range
	0 ... +2000 mV	<0 mV	• >+2000 mV
	0 ... -2000 mV	>0 mV	• <-2000 mV

Tab. 8: Output signal of the sensor when overdriven/underdriven

## 8.2 Special checks

### 8.2.1 Electronics



If an RV1 is present:

- ▶ Grip the sleeve and unscrew the RV1.
  
- ▶ Rinse the working electrode / counter electrode with mains water.
- ▶ Using a clean cloth, carefully dry the working electrode / counter electrode.
- ▶ Connect the sensor to the measuring and control device.
- ▶ Connect a suitable measuring device to the original sensor signal.
- ▶ Wait five minutes.
- ▶ Read the original sensor signal at the measuring device.
- ▶ Mark up the values that were read against the following target values:
  - Sensor (mV): approx. +/- 0 mV
  - Sensor (mA): approx. 4 mA
  - Sensor (Modbus): approx. 0 ppm or 0%

If the sensor signal corresponds roughly with the above value, the electronics can provisionally be regarded as OK.

If the measured value deviates significantly from the above value:

- ▶ Return the sensor to the supplier for checking.

---

## 8.2.2 Checking the zero point

- ✓ The electronics must have been tested and found to be OK.
- ▶ Connect the sensor to the measuring and control device.
- ▶ Fill a glass beaker with mains water (without any disinfectant!).
- ▶ Stir the sensor round in the glass beaker for 30 seconds.
- ▶ Carefully put the sensor down obliquely in the glass beaker.
- ▶ Wait 30 minutes.
- ▶ Read the measuring value.

If the measuring value is close to the value 0, the zero point can provisionally be regarded as OK.

If the measuring value deviates significantly from zero:

- ▶ Perform maintenance on the sensor (see section 7, p. 26) and repeat the zero point test.



A freshly cleaned working electrode has a relatively high zero point. The sensor takes a few days to settle back to its lowest zero point.

If after maintenance has been performed on the sensor measuring value is not close to zero:

- ▶ Return the sensor to the supplier for checking.
- ↪ This completes the zero point checking.

### 8.2.3 Signal

- ✓ The zero point checking must have been performed successfully.
- ▶ Add the relevant disinfectant to the mains water in the glass beaker (see section 8.2.2, p. 39).
- ▶ Stir the sensor steadily round in the glass beaker for five minutes.
- ▶ Monitor the measuring value throughout this time.

If the measuring value increases, the sensor can provisionally be regarded as OK.

If the measuring value does not change:

- ▶ Perform maintenance on the sensor (see section 7, p. 26) and repeat the signal test.
- ↪ This completes the signal test. The sensor can be put back into use.

If after maintenance the sensor shows no response to the disinfectant:

- ▶ Return the sensor to the supplier for checking.



---

## 9 Technical data

Information on the technical data can be found at the following Internet address:

<https://reiss-gmbh.com/data-sheets/?lang=en>

## 10 Deinstallation and storage

To deinstall a sensor and prepare it for storage, proceed as follows:

### 10.1 Wet storage

- ▶ Perform a change of electrolyte as a maintenance operation (see section 7.3, p. 28).
- ▶ Fill the protective cap with electrolyte.
- ▶ Screw the filled protective cap on to the sensor.
- ▶ Use mains water to rinse off any electrolyte residues adhering to the sleeve, and dry it with a clean cloth.
- ↪ The sensor can be stored for up to a year in a dry dust-free place.

### 10.2 Dry storage (only for the AS2)

- ▶ Unscrew the sleeve.
- ▶ Use mains water to rinse the sleeve.
- ▶ Rinse the electrode finger with mains water.
- ▶ Use mains water to rinse the protective cap.
- ▶ Dry the sleeve, sensor body and protective cap in a dust-free place.
- ▶ Screw the sleeve on to the sensor body.
- ▶ Screw the protective cap on to the sleeve.

## 11 Disposal

- ▶ Comply with the local regulations on disposal.

## 12 Warranty

We grant a manufacturer's warranty of two years on the sensor body and the electronics, subject to correct handling. The warranty does not apply to the sleeve (wearing part), electrolyte (expendable material) and service work to be performed (cleaning the parts in contact with the electrolyte, renewing the reference electrode and cleaning the electrode tip with special emery paper). If there is mechanical damage or the serial number is illegible, the warranty becomes void.

### **Returning a sensor for checking/factory reconditioning:**

Shipments will be accepted only if they are returned carriage paid. Otherwise it will be returned to the sender.

Each return shipment must be accompanied by a completed declaration of clearance. This can be found at the following Internet address: <https://www.reiss-gmbh.com/forms/?lang=en>. In case of contamination or missing or not completed declaration of clearance, a cleaning fee will be charged.

On checked/reconditioned sensors we grant a warranty of one year from the date of checking/reconditioning. The warranty is on the electrode body and the electronics, subject to correct handling.

If there is mechanical damage or the serial number is illegible, this warranty becomes void.

## 13 Liability disclaimer

The sensor is manufactured with great care and is subjected to a documented function test. Should any malfunctions occur in the sensor despite this, no liability claims may be lodged against the manufacturer for damages resulting from this malfunction.

Reiss GmbH  
Eisleber Str. 5  
D - 69469 Weinheim  
Germany